

润泽流体 Runze Fluid

南京润泽流体控制设备有限公司是一家集研发、生产、销售于一体的高科技企业。公司秉承“品质为本，诚信立业，专注于为客户提供卓越的流体传输解决方案”的宗旨竭诚欢迎国内外新老客户光临，携手共进，互惠互利，共创未来。



SV-01 Multiport Valve



南京润泽流体控制设备有限公司

NANJING RUNZE FLUID CONTROL EQUIPMENT CO.LTD

Catalogue

CHAPTER 1 COMPANY INTRODUCTION	2
CHAPTER 2 PARAMETERS&FUNCTION	2
2.1 PRODUCT FEATURES.....	2
2.2 NAMING RULES	3
2.3 PRODUCT STRUCTURE	3
2.4 PRODUCT DIMENSION.....	4
2.5 PRODUCT INSIDE STRUCTURE.....	5
2.6 TECHNICAL PARAMETERS	5
2.7 VALVE PORTS.....	6
2.8 PORT DEFINITION.....	7
CHAPTER 3 DRIVER CONTROLLER INSTRUCTION	7
3.1 GENERAL INTRODUCTION.....	7
3.2 CODE INSTRUCTIONS	8
3.2.1 <i>Commands list</i>	8
3.2.2 <i>Control command format</i>	9
3.2.3 <i>Command Format Instruction</i>	10
3.3 OPERATION STEPS (TAKE RS232 AS EXAMPLE)	15
CHAPTER 4 DEBUG INSTRUCTIONS	20
4.1 DEBUG.....	20
4.1.1 <i>RS232 Debug Instructions</i>	20
4.1.2 <i>RS485 Debug Instructions</i>	23
4.1.3 <i>CAN Debug Instructions</i>	27
4.2 COMMON PROBLEMS AND SOLUTIONS.....	29

Chapter 1 Company Introduction

Nanjing RUNZE Fluid control equipment Co., LTD is a high-tech enterprise specialized in electronic research and development, mechanical design, mould manufacturing and scientific analysis instruments & parts which are widely used in bioanalysis, environmental inspection, lab research, chemical industrial production etc. RUNZE FLUID has been integrated with professional experts, high technology and rich practical experience on products series such as multichannel switching valve, injection syringe pump, gastight glass syringe, intelligent automatic peristaltic pump, OEM pump head and solenoid valve etc. during past few years. RUNZE FLUID also devote ourselves to providing customers with technical support on their new prototype research and various fluidic path solutions.

Chapter 2 Parameters&Function

2.1 Product Features

Multiport switching valves are also named selector valve, sampling valve, injection valve or electric rotary valve, it is one of the patented products in RUNZE FLUID.

1. Controller

Multiport switching valves realize different fluid paths by switching the rotor after stepper motor received commands from upper monitor. They are integrated with RS232/RS485/CAN for convenient control.

2. Corrosion resistance

Valve core (spool) was made of ceramic or sapphire which are suitable for all corrosive liquid and liquid with small particles; valve head was processed with PCTFE and 316 stainless steel, free maintenance. Liquid will not touch stainless steel part.

3. Valve core structure

Multi-directional self-adaptive plane switching structure design to effectively extend the service life.
(The structure patent No. CN204852471U)

4. Drive

High reliability NMB motor with planetary reducer gearbox

5. Location

Valve location by encoder Optocoupler to avoid inaccurate location after speed reducer gearbox worn out.

6. Driver

The driver module use low power consumption driver chip to effectively reduce the working heat to ensure high performance.

7. Communication

The valve was integrated with communication RS232/RS485/CAN for flexible control.

8. Controller interface

XH terminal with spacing 2.54mm

9. Function

Switching valves are widely used in sample collection and distribution.

10. Application

Life and science research such as environmental test instruments, laboratory analytical devices, medical analyzers, chromatograph.

2.2 Naming Rules

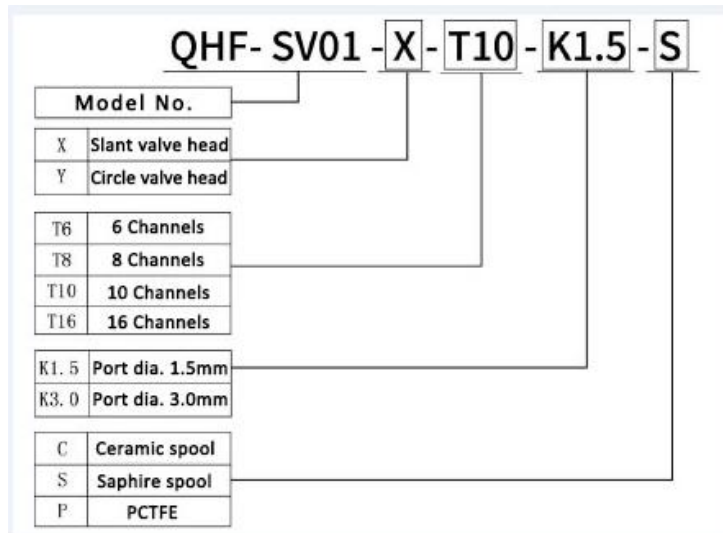

E.g.: QHF-SV01-Y-T6-K1.5-S means 6 port circle type switching valve port diameter 1.5mm sapphire valve core

2.3 Product Structure

Switching valve can be classified as circle and slant type according to liquid flow direction; it can be classified as 6 channels, 8 channels, 10 channels, 16 channels according to channel numbers.



Slant



Circle

Slant type				Circle type	
6 channels	8 channels	10 channels	16 channels	6 channels	8 channels
1/4-28UNF Female thread					

2.4 Product Dimension

Slant Switching Valve

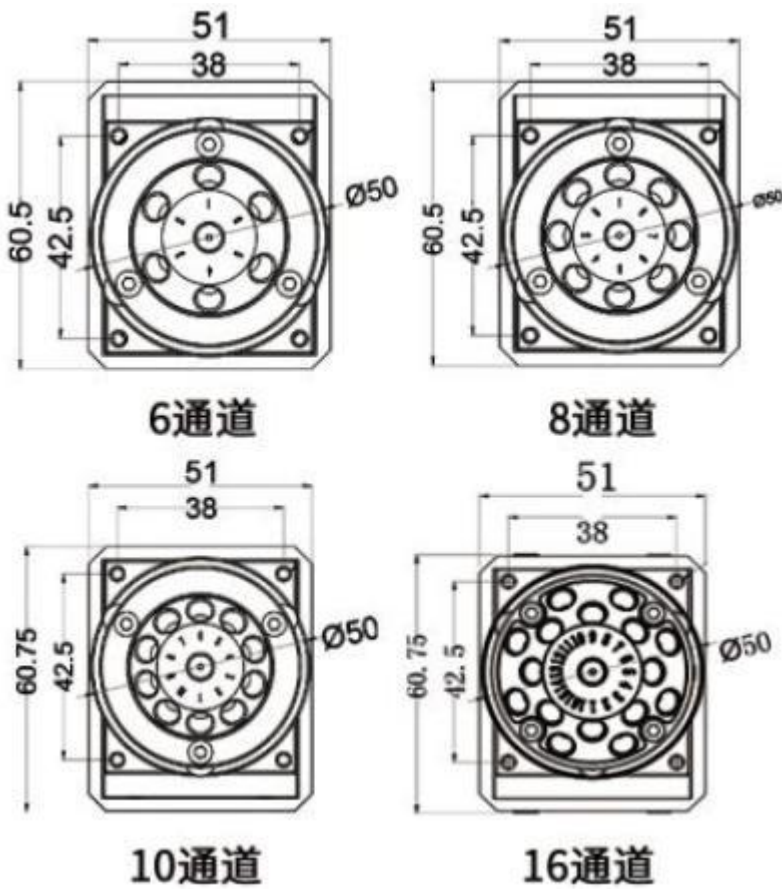

Circle Switching Valve

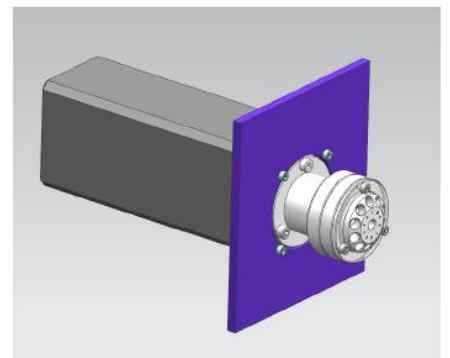
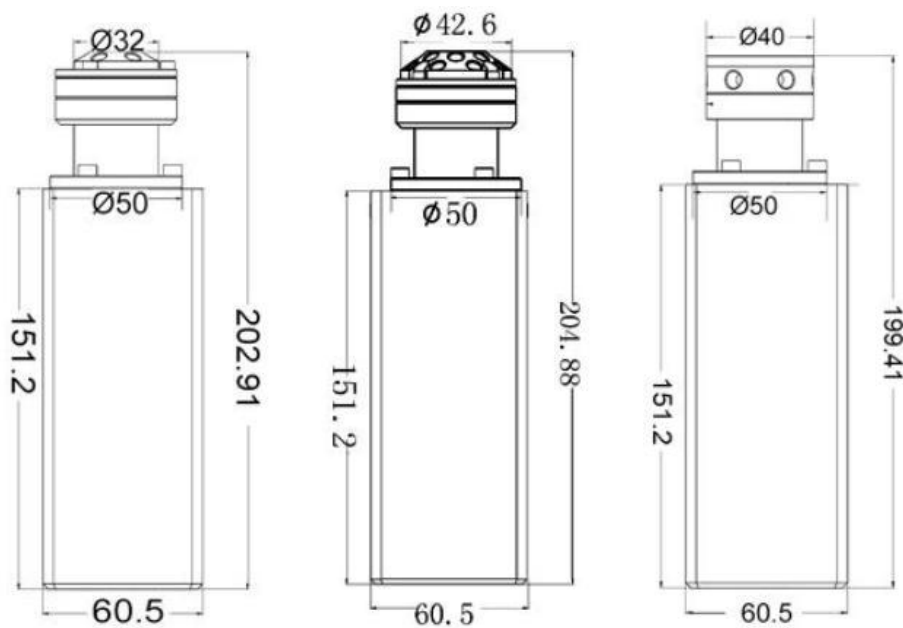
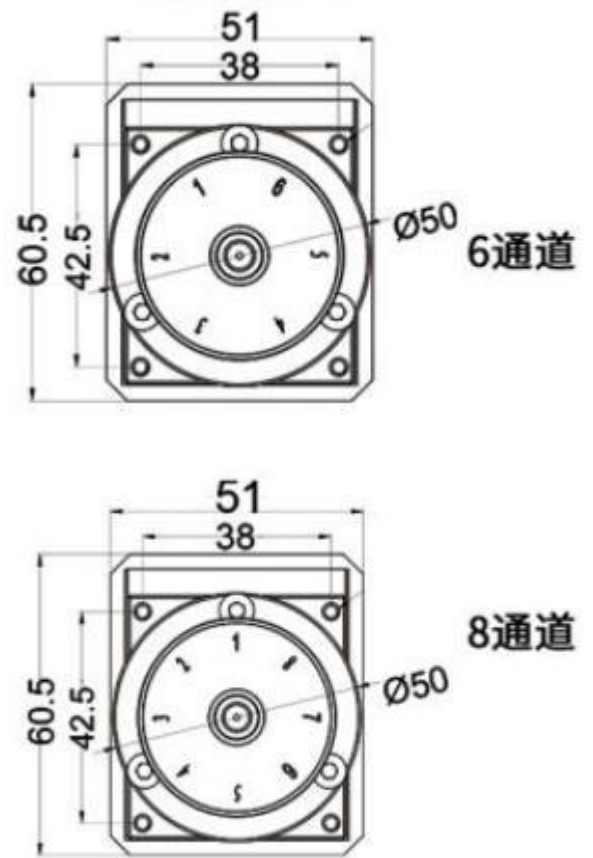

2.5 Product Inside Structure

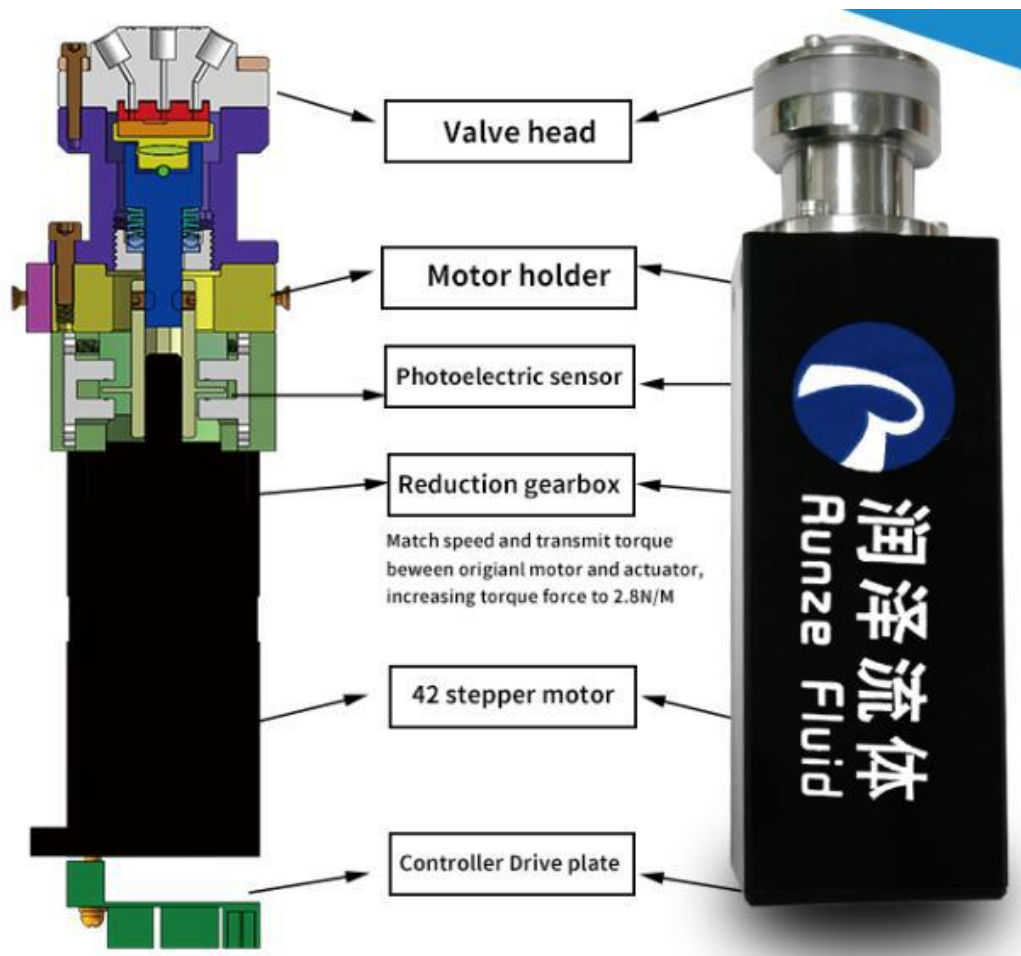

2.6 Technical Parameters

Name	Parameters
Fluid Path	PCTFE, Ceramic, Sapphire
Original Position Detection	Auto detection original location after powered on
Port to Port Volume (Dead Volume)	4.5 μ L
Port Diameter	1.5mm/3.0mm customize support
Operating Temperature	0-50 $^{\circ}$ C
Operating Humidity	\leq 80%
Liquid Temperature	0-80 $^{\circ}$ C
Connection	1/4-28UNF Female thread
Replacements	Stator replaceable, Rotor sealed
Switching Feature	Random start to any ports

Driver	Not replaceable/optional	
Switch Speed	100-280ms	
Maximum Drive Force/ Torque Force	3N/M	
Secondary Drive Force/ Torque Force	0.36N/M	
Communication	RS232/RS485/CAN	
Baud Rate	9600dps, 9200dps, 38400dps, 57600dps, 115200dps	
Device Address Settings	Serial Pont	
Device Parameters Settings	Serial Pont	
Dimension (L*W*H)	61*51*205mm	
Power Supply	DC24V/2A	
Max. Current	1.5A	
Max. Power	36W	
Air Pressure	0-1.0Mpa	
Water Pressure	0-1.6Mpa	
Net Weight	Slant switch valve	1.225kg
	Circle switch valve	1.25kg
OEM support for special requirements		

2.7 Valve Ports

Central one is the public port, rotor rotates to switch from port to port.

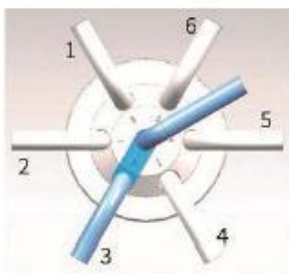

6通道

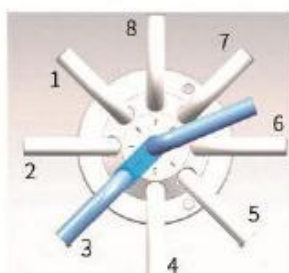

8通道

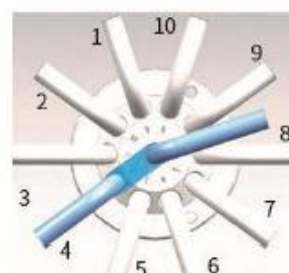

10通道



16通道

2.8 Port Definition

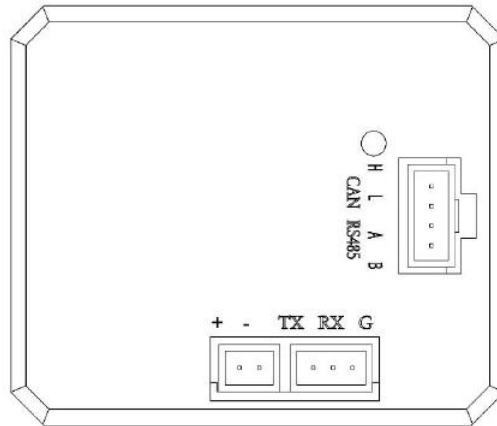

Port Code	Function
+	DC24V Positive
-	DC24V Negative
TX	RS232 Data output
RX	RS232 Data input
GND	RS232 Earth wire
H	CAN Communication H
L	CAN Communication L
A	RS485A
B	RS485B

Chapter 3 Driver Controller Instruction

3.1 General introduction

Communication form: Asynchronous serial communication; Commands and data frames by 2Byte sum check. Commands and data are hexadecimal numbers which are saved by little-endian mode.

More instructions:

Communication interface:RS-232,RS-485,CAN

Communication mode: Bidirectional asynchronous; master-slave mode

Baud rate: 9600bps, 19200bps, 38400bps, 57600bps, 115200bps (RS232/ RS485) 100K, 200K, 500K, 1M (CAN)

Data bit: 8

Even-odd check: None

Response time <1 second

3.2 Code Instructions

3.2.1 Commands list

Table 3-1 Commands list

Command setting

Command code	Instruction	Factory /common command	Byte numbers
0x00	Address setting	Factory command	4
0x01	RS232 baud rate setting	Factory command	4
0x02	RS485 baud rate setting	Factory command	4
0x03	CAN baud rate setting	Factory command	4
0x07	Maximum speed setting	Factory command	4
0x0a	Setting 1 circle encoder counts	Factory command	4
0x0b	Reset speed setting	Factory command	4
0x0c	Reset direction setting	Factory command	4
0x0e	Setting automatic reset when power on	Factory command	4
0x10	CAN destination address setting	Factory command	4

Inquiry Command

Command code	Instruction	Factory /common command	Byte numbers
0x20	Inquiry address	Common command	2
0x21	Inquiry RS232 baud rate	Common command	2
0x22	Inquiry RS485 baud rate	Common command	2

0x23	Inquiry CAN baud rate	Common command	2
0x27	Inquiry maximum speed	Common command	2
0x2a	Inquiry count of 1 circle encoder	Common command	2
0x2b	Inquiry reset speed	Common command	2
0x2c	Inquiry reset direction	Common command	2
0x2e	Inquiry automatic reset when power on	Common command	2
0x30	Inquiry CAN destination address	Common command	2
0x3e	Inquiry current located port	Common command	2
0x3f	Inquiry current version	Common command	2

Table 3-2 Response status

Response status	
Code B2	Parameter Instruction
0x00	Normal state
0x01	Frame error
0x02	Parameter error
0x03	Optocoupler error
0x04	Motor busy
0xfe	Task suspension
0xff	Unknown error

3.2.2 Control command format

Message frame of "Send command" is 8 bytes, full format as follow:

Table 3-3 Send command (common command)

Send command	Start code	Address bits	Control command	Command parameter	End code	Sum check
Byte code	B0	B1	B2	B3, B4	B5	B6, B7
Byte number	1	1	1	2	1	2

Note: Above command format refers to common send commands.

Kind reminder: Password bit was added in factory commands, parameter bit was also changed from 2 byte to 4 byte, the command format as follow:

Message frame of “Factory command” is 14 bytes, full format as follow:

Table 3-4 Send command (Factory command)

Send command	Start code	Address bits	Control command	Password	Command parameter	End code	Sum check
Byte code	B0	B1	B2	B3/B4 B5/B6	B7/B8 B9/B10	B11	B12, B13
Byte numbers	1	1	1	4	4	1	2

Message frame of “Response command” is 8 bytes, full format as follow:

Table 3-5 Response command

Response command	Start code	Address bits	Response status	Response parameters	End code	Sum check
Byte code	B0	B1	B2	B3, B4	B5	B6, B7
Byte numbers	1	1	1	2	1	2

Note: Send command and response command share the same format, all the message frame of response commands are 8 bytes.

3.2.3 Command Format Instruction

Table 3-6 Start code and end code B0,B5 (B11)

Name	Code
Start code B0	0xCC
End code B5 (B11)	0xDD

Note: Start code and end code in common command (send & response command) are same with B0 and B5; But end code of factory command is B11.

Table 3-7 Address bit (B1)

Name	Abbreviation	Code B1
Address bit	address	0xXX

- Note:** 1. Send command and response command share the same address bit
 2. "XX" in "0xXX" means settable, factory default code is 0x00, parameter range is 0x00 ~ 0xFF.

Table 3-8 Control code instruction (B2 ~ B10)

Command setting (Factory command)(B2 ~ B10)

Code B2	Abbreviation	Password B3/B4/B5/B6	Parameter instruction B7 B8 B9 B10
0x00	Address setting	B3=0xFF B4=0xEE B5=0xBB B6=0xAA	B7=0xXX (B8=0x00 B9=0x00 B10=0x00) value range of XX is 00 ~ FF, defaults is 00
0x01	RS232 baud rate setting	B3=0xFF B4=0xEE B5=0xBB B6=0xAA	Total 5 baud rates: factory default 9600bps (B8=0x00 B9=0x00 B10=0x00) B7=0x00 baud rate 9600bps B7=0x01 baud rate 19200bps B7=0x02 baud rate 38400bps B7=0x03 baud rate 57600bps B7=0x04 baud rate 115200bps
0x02	RS485 baud rate setting	B3=0xFF B4=0xEE B5=0xBB B6=0xAA	
0x03	CAN baud rate setting	B3=0xFF B4=0xEE B5=0xBB B6=0xAA	Total 4 baud rates: factory defaults 100K (B8=0x00 B9=0x00 B10=0x00) B7=0x00 baud rate 100K B7=0x01 baud rate 200K B7=0x02 baud rate 500K B7=0x03 baud rate 1M

0x0c	Reset direction setting	B3=0xFF B4=0xEE B5=0xBB B6=0xAA	(B8=0X00 B9=0x00 B10=0x00) B7=0x00 means C.W. B8=0x01 means C.C.W.
0x07	Maximum speed setting	B3=0xFF B4=0xEE B5=0xBB B6=0xAA	B7=0xXX B8=0xXX B9=0x00 B10=0x00 value range of B8B7 is 0x0005~0x015E, Set speed as 5~350rpm (factory default as 200rpm, that is B7=C8) Note: 5~350rpm is the best operation speed, when speed was set lower than 5rpm or higher than 350rpm, switching valve may works abnormally.
0x0a	Setting 1 circle encoder counts	B3=0xFF B4=0xEE B5=0xBB B6=0xAA	B7=0xXX (B8=0x00 B9=0x00 B10=0x00) XX depends on valve channel numbers (excluding public channel), XX should be over 0. This setting as available after restoring factory settings.
0x0b	Set reset speed	B3=0xFF B4=0xEE B5=0xBB B6=0xAA	B7=0xXX B8=0xXX (B9=0x00 B10=0x00) value range of B8B7 as 0x0005~0x015E, Set speed 5-350rpm (factory default reset speed as 100rpm, that is B7=64) Note: speed 5~350rpm means the best operation status of switching valve, not means speed can't be bigger than this range. When speed been set lower than 5rpm or higher than 350rpm, switching valve may works abnormally.

0x0e	Set automatic reset when power on	B3=0xFF B4=0xEE B5=0xBB B6=0xAA	(B8=0x00 B9=0x00 B10=0x00) B7=0x00 means non-automatic reset B7=0x01 means automatic reset Automatic reset when powered on means motor automatically reset to optocoupler when powered on (6 port valve reset between port 1 and 6; 8 port valve reset between port 1 and 8; 10 port valve reset between port 1 and 10)
0x10	Set CAN destination address	B3=0xFF B4=0xEE B5=0xBB B6=0xAA	B7=0xXX (B8=0x00 B9=0x00 B10=0x00) value range of XX is 00 ~ FF, default as 00

Inquiry Command (Common command) (B2 ~ B4)

Code B2	Abbreviation	Parameter instruction B3 B4
0x20	Address checking	B3=0x00 B4=0x00
0x21	Inquiry RS232 baud rate	B3=0x00 B4=0x00
0x22	Inquiry RS485 baud rate	B3=0x00 B4=0x00
0x23	Inquiry CAN baud rate	B3=0x00 B4=0x00
0x27	Inquiry Maximum speed	B3=0x00 B4=0x00
0x2a	Inquiry 1 circle encoder counts	B3=0x00 B4=0x00
0x2b	Inquiry reset speed	B3=0x00 B4=0x00
0x2c	Inquiry reset direction	B3=0x00 B4=0x00
0x2e	Inquiry automatic reset when powered on	B3=0x00 B4=0x00
0x30	Inquiry CAN destination address	B3=0x00 B4=0x00
0x3e	Inquiry current located port number	B3=0x00 B4=0x00
0x3f	Inquiry current version	B3=0x00 B4=0x00

Table 3-9 Sum Check (B6, B7)

Name	Abbreviation	Code B6,B7	Remark
Sum Check	Sum Check	0xXX 0xXX	XX=sum from start to end code

Note: Sum check of factory command is B12,B13

Table 3-10 Response parameter B2 B3 B4

Code B2	Instruction	Other parameter directions=B3 B4
0x00	Normal state	B3=0x00 B4=0x00 E.g.: When send inquiry command "0x3e", response command B3 B4 is 0x01; 0x00~0x0a, 0x00 means valve channel 1 to 10, Parameter=0xFF, 0xFF means valve now stops at reset Optocoupler
0x01	Frame error	Parameter=0x00 0x00
0x02	Parameter error	Parameter=0x00 0x00
0x03	Optocoupler error	Parameter=0x00 0x00
0x04	Motor busy	Parameter=0x00 0x00
0xfe	Task suspension	Parameter=0x00 0x00
0xff	Unknown error	Parameter=0x00 0x00

Instructions:

- Code B2 in response command means current motor status. Only when B2=0x00 motor works normally. Other status parameters are in above table.

Kind reminder: When device controlled by RS485 and send command B2-0x44 or 0x45, status parameter in response command is FE (task suspension) which means motor is working as command told, if now send other commands (except for Inquiry command), the status parameter in response command will be 04 (motor busy), if send polling command 0x4a, the status parameter in response command will be 00 (normal status).

See below chart for ref.:

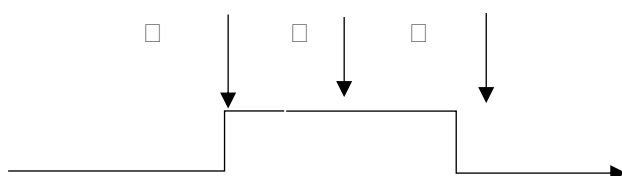

operating

B2 FE 04 00 t

- Send control command (B2=0x41 or 0x42, 0x45)
- Send other control commands
- Send polling command 0x4a

(2) Other parameters B3,B4 in response command make sense only when send inquiry command; when send setting or control command, response parameters make no sense with default 00 00. When send inquiry command and parameter B2 in response command is 00, then response parameter B3, B4 make sense, received value is the inquiry result. E.g. when send inquiry command 0x21 (Inquiry RS232 baud rate), response command B3 B4 = 04 00, it means baud rate of RS232 is 115200bps.

Note: all command parameters are set and saved by little-endian mode. Little-endian means lower data bit saved in the lower address bit, higher data bit saved in the higher address bit.

3.3 Operation steps (Take RS232 as example)

1. Powered on the device
2. Check out “Factory command” if needed; directly set the parameters if no need process factory command
3. Restart the device after finish settings (24v power supply must be cut off before restart the device)

E.g.1 Set maximum speed (200rpm)

1. Check out “factory command” as Figure 1

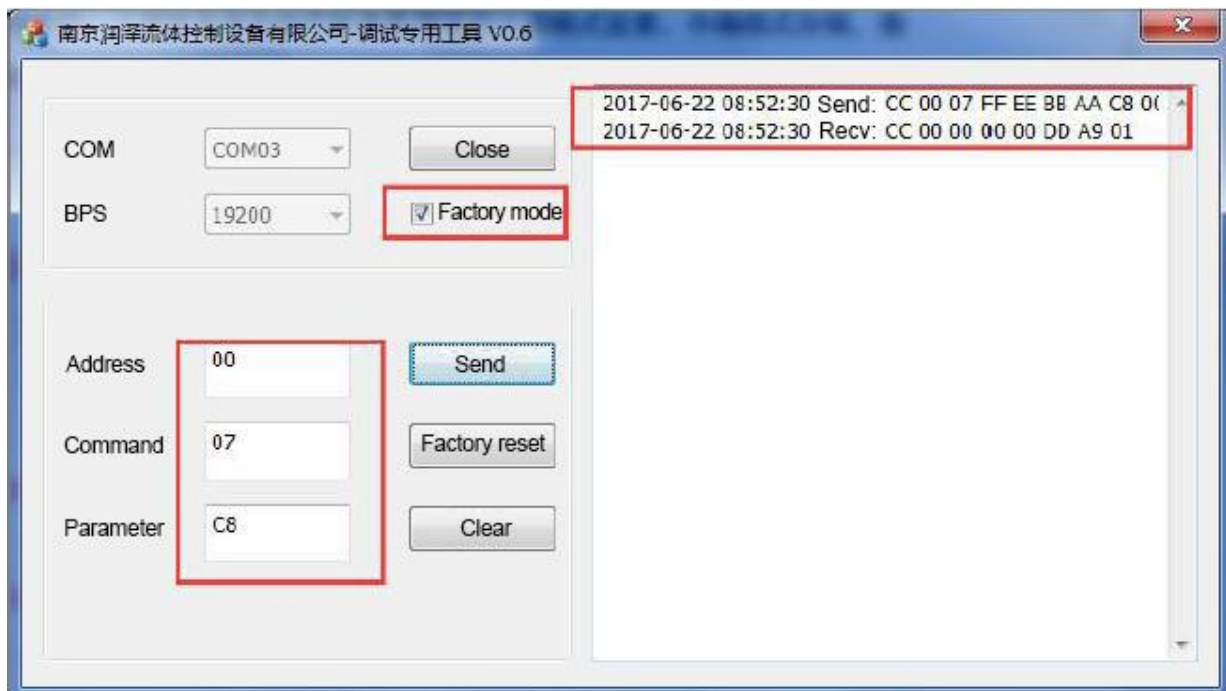

Figure 1

2. Input "00" into "Address" (default 00, if address has been changed then input new address); Input speed setting code "07" into "Command"; Input target speed "C8" into "Parameter"; Click "send", if received commands as Figure 1, it is correct settings. (Parameters must be hexadecimal)

3. Cancel the chosen "Factory command" (as Figure 2)

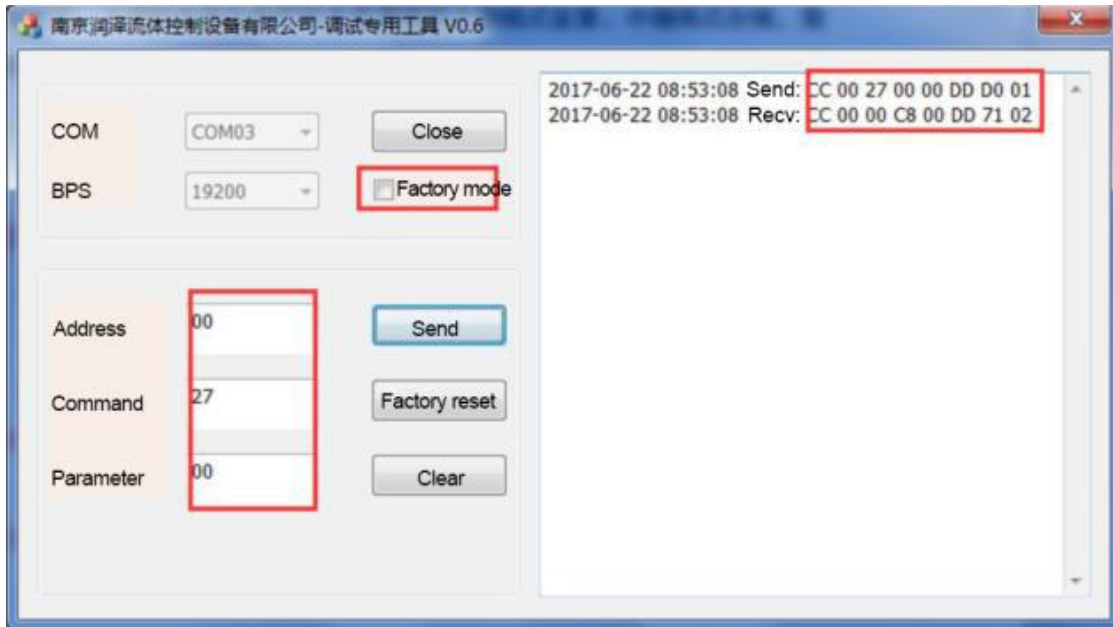

Figure 2

3. Inquiry the set speed by input speed setting code "27" into "Command" and input "00" into "Parameter", click "send", received command B3 = C8 which means maximum set speed is 200rpm (if input "parameter" is not "00", received command will be "02" which means parameter error)

4. After confirmed set speed is correct, the speed comes into effective after restart the device (24v power supply must be cut off before restart the device)

Note: There are two modes: dynamic speed setting and factory speed setting, when send dynamic speed setting command 4B, you do not need check out "Factory command") and set speed is current working speed, it will be invalid after device powered off. If you did not set the speed, default speed will be maximum speed whose command code is 07.

E.g.2 Setting RS232 Baud Rate

1. Check out "Factory command" (as Figure 3)

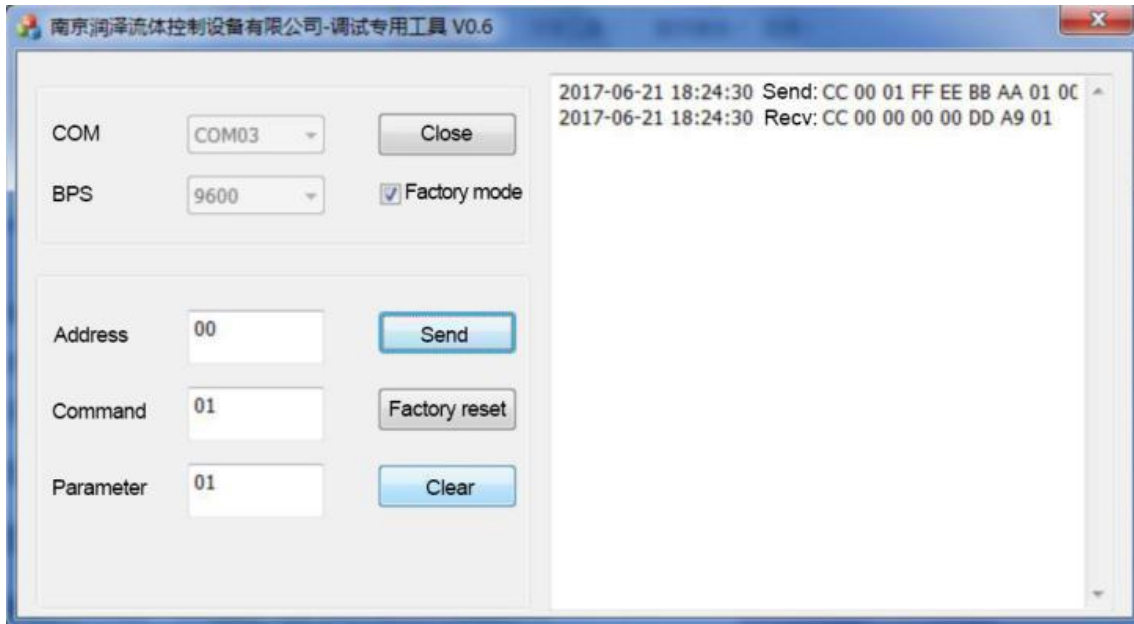

Figure 3

2. Input "00" into "Address" (default as 00, if address has been changed then input new address); Input speed setting code "01" into "Command"; Input target speed code "01" into "Parameter"; Click "send" , if received commands as Figure 3, settings are correct. (All the parameters are hexadecimal)
3. Cancel the chosen "Factory command" (as Figure 4)

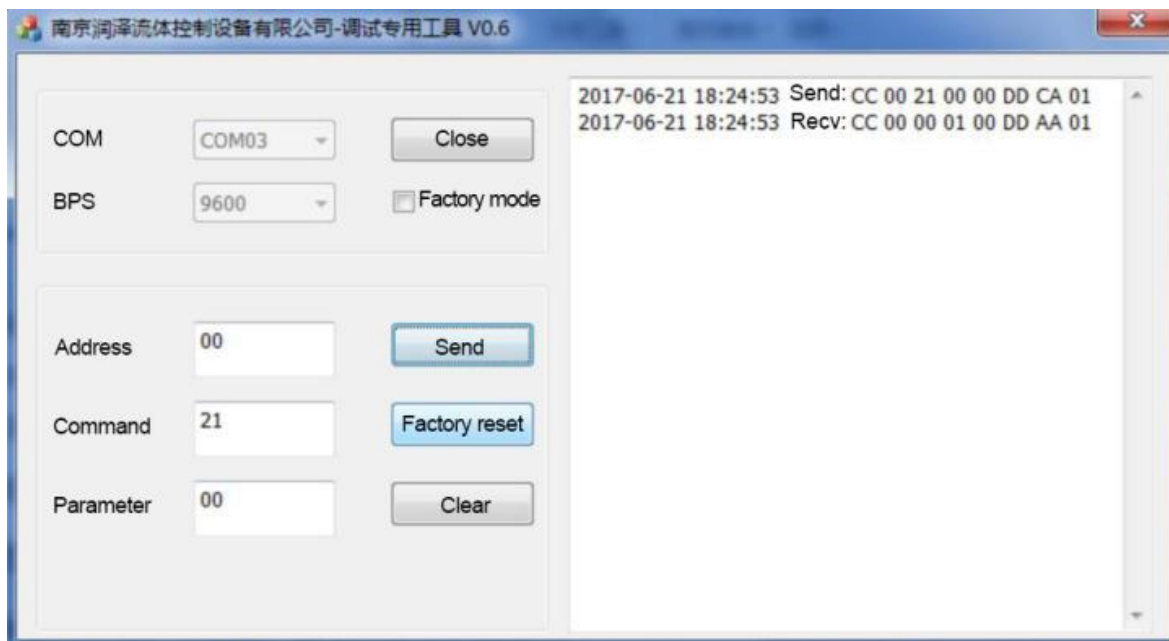

Figure 4

4. Inquiry set speed, input speed setting code "21" into "Command" and input "00" into "Parameter", click "send", if received commands as Figure 4, settings are correct.
5. Inquiry baud rate to ensure it is correct, then restart the device (24v power supply must be cut off before restart the device), set RS232 baud rate come into effect.

6. Restart the device, baud rate will same as set baud rate (as Figure 5)



Figure 5

E.g.3 Inquiry motor status (as Figure 6)

1. Input "00" into "Address" (If address has been changed, then input new address)
2. Input "4A" into "Command" (Inquiry motor status)
3. Input "00" into "Parameter" (if input code is not 00, received command will be 02 which means parameter error)
4. Click "send" after input all the command codes, motor status data will be received at the right display box.

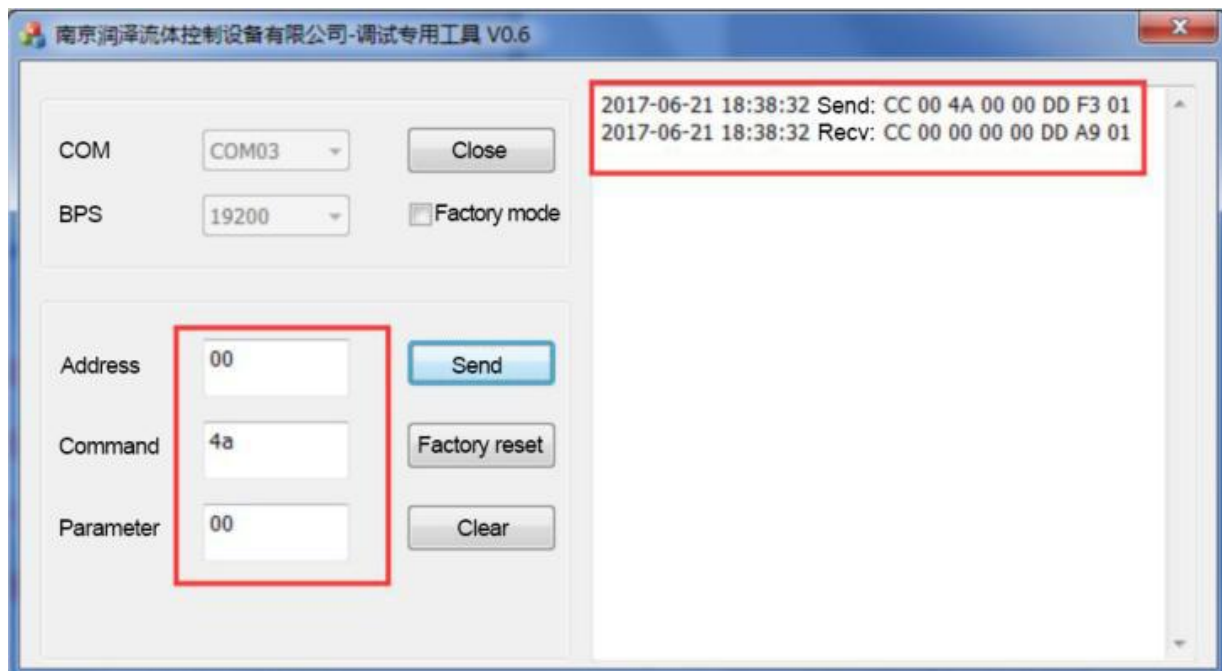

Figure 6

E.g.4 Control device switch to port 4

1. Input "00" into "Address" (if address has changed then input new address), input "45" into "Command", input "00" into "Parameter", click "send", then switching valve will reset to port 1 and port 6/8/10/10
2. If input parameter data is not 00, received code will be 02 which means parameter error.

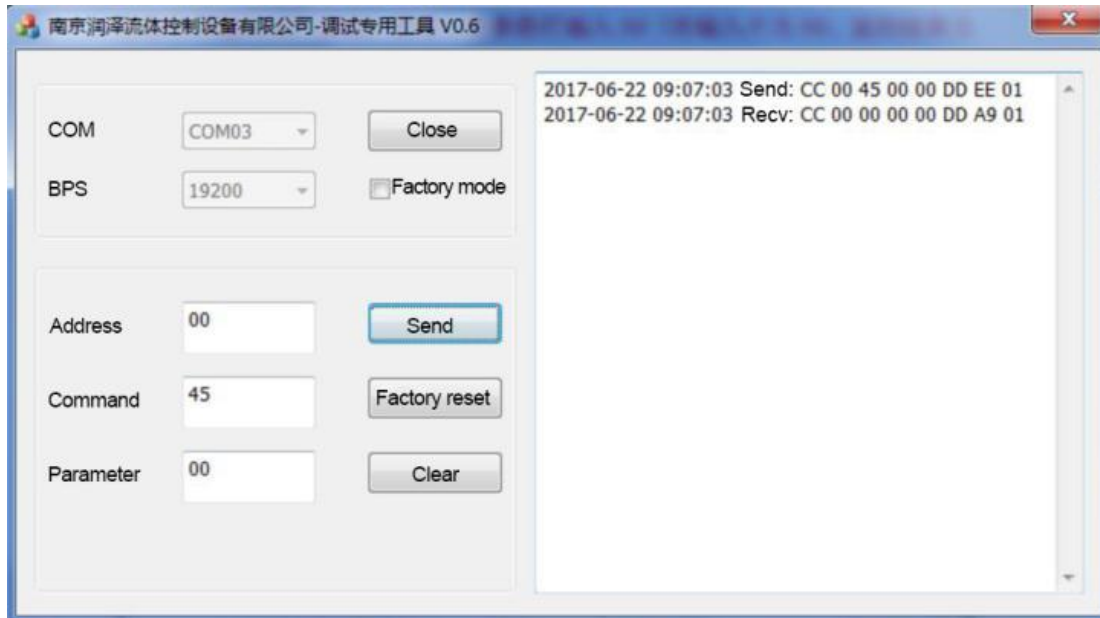

Figure 7

3. Input "00" into "Address" (if address has been changed, then input new address), input "44" (motor rotates by encoder to automatically choose best path) into "Command", input "04" into "Parameter", click "Send", switching valve will rotate to port 4 and link with public port, received commands as Figure 8.

Note: If input parameter data is not 00, received code will be 02 which means parameter error.

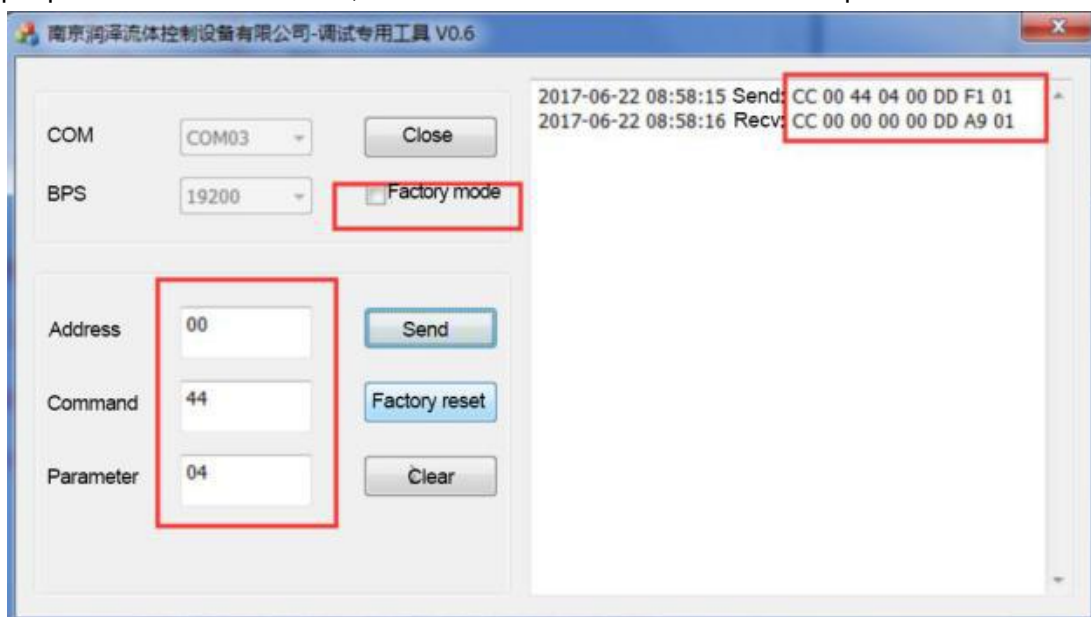

Figure 8

Chapter 4 Debug Instructions

4.1 Debug

4.1.1 RS232 Debug Instructions

(1) RS232 Debug: Motor Tester V0.6.exe

Since no RS232 communication interface on computer, so we need to realize the communication by USB. Check current serial port from Device Manager of computer (as figure 9 which shows several serial port, we need to confirm which COM is available and correct.), after choose the correct COM which will show in control interface as figure 10, baud rate should be device baud rate, factory default as 9600bps, click "open" and input address, command, parameter, command should be correspond with B2 codes (see table 3-8), parameters correspond with B3,B4; if use factory command, check the blank of factory command; if use common commands then no need this check. Send the commands after settings, these sent code and received received code will be shown at right side display box.

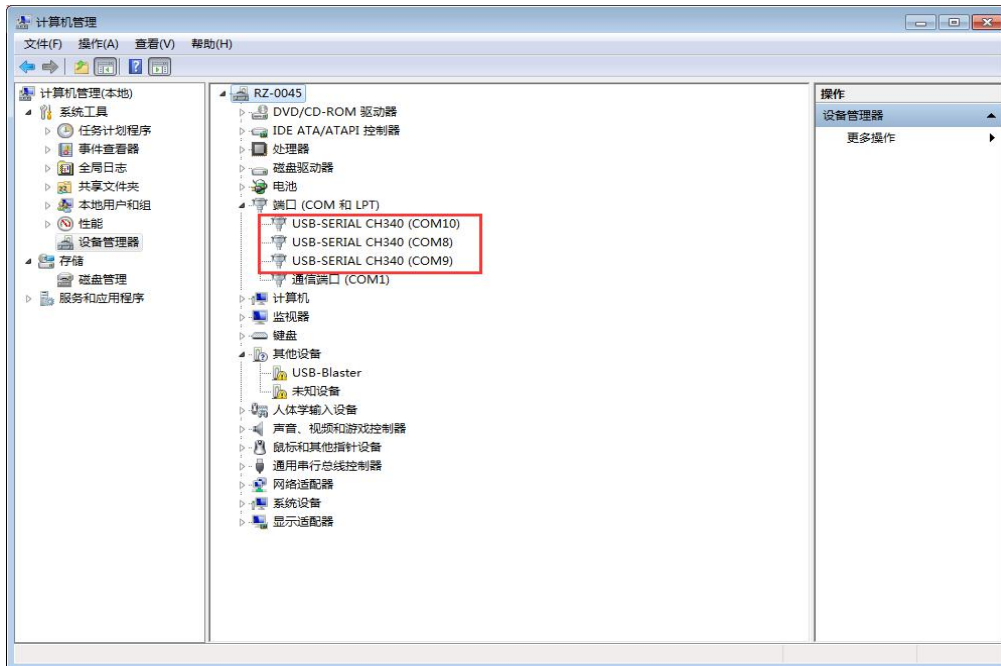

Figure 9



Figure 10

The "empty" button in debug refers to clear the right side contents in command display box; "factory reset" means to return all the settings to factory default status.

Note: Set encoder counts according to current channel numbers immediately after return to factory default status, or valve will work abnormally. The address, command, parameter need to be input hexadecimal numbers.

- Take RS232 communication as example
- Send command: Setting RS232 baud rate

B0	B1	B2	B3	B4	B5	B6	B7	B8	B9	B10	B11	B12	B13
0xCC	0x00	0x01	0xFF	0xEE	0xBB	0xAA	0x04	0x00	0x00	0x00	0xDD	0x00	0x05

Response command

B0	B1	B2	B3	B4	B5	B6	B7
0xCC	0x00	0x00	0x00	0x00	0xDD	0xA9	0x01

Baud rate setting is factory command, so check out "factory command", operation results Figure 11:

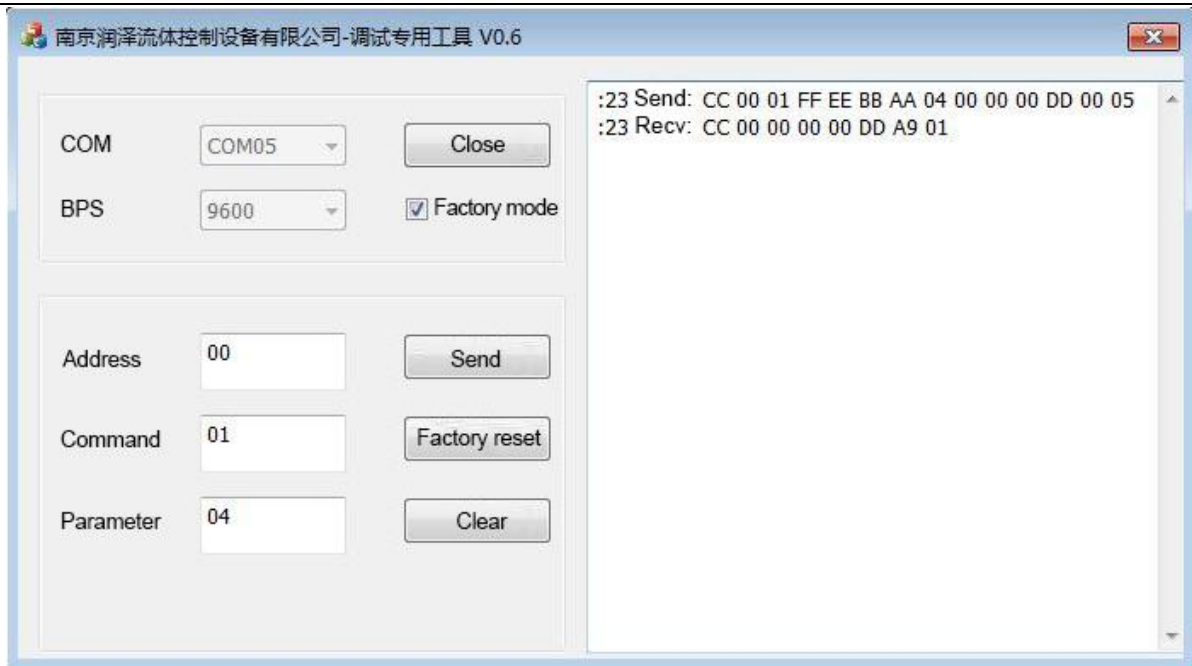

Figure 11

If received command B2=00, then switching valve now work normally, settings are successful.

- Send command: Inquiry reset speed

B0	B1	B2	B3	B4	B5	B6	B7
0xCC	0x00	0x2b	0x00	0x00	0xDD	0xD4	0x01

Response command

B0	B1	B2	B3	B4	B5	B6	B7
0xCC	0x00	0x00	0xC8	0x00	0xDD	0x71	0x01

Inquiry command is common command, operation result as Figure 12:



Figure 12

Note: Parameter bit of response command is C8 00 which is saved by Little-Endian that lower data bit saved at lower address bit, hexadecimal 0x00C8 = decimal 200, so reset speed is 200rpm.

4.1.2 RS485 Debug Instructions

(1) RS485 Debug: MotorTester V0.6.exe

RS485 and RS232 communication share the same debug tool and same usage method, please take above RS232 debug instructions for reference. Below are several examples:

- Send command: Inquiry current motor status

B0	B1	B2	B3	B4	B5	B6	B7
0xCC	0x00	0x4a	0x00	0x00	0xDD	0xF3	0x01

Response command

B0	B1	B2	B3	B4	B5	B6	B7
0xCC	0x00	0x00	0x00	0x00	0xDD	0xA9	0x01

Operation results as Figure 13:

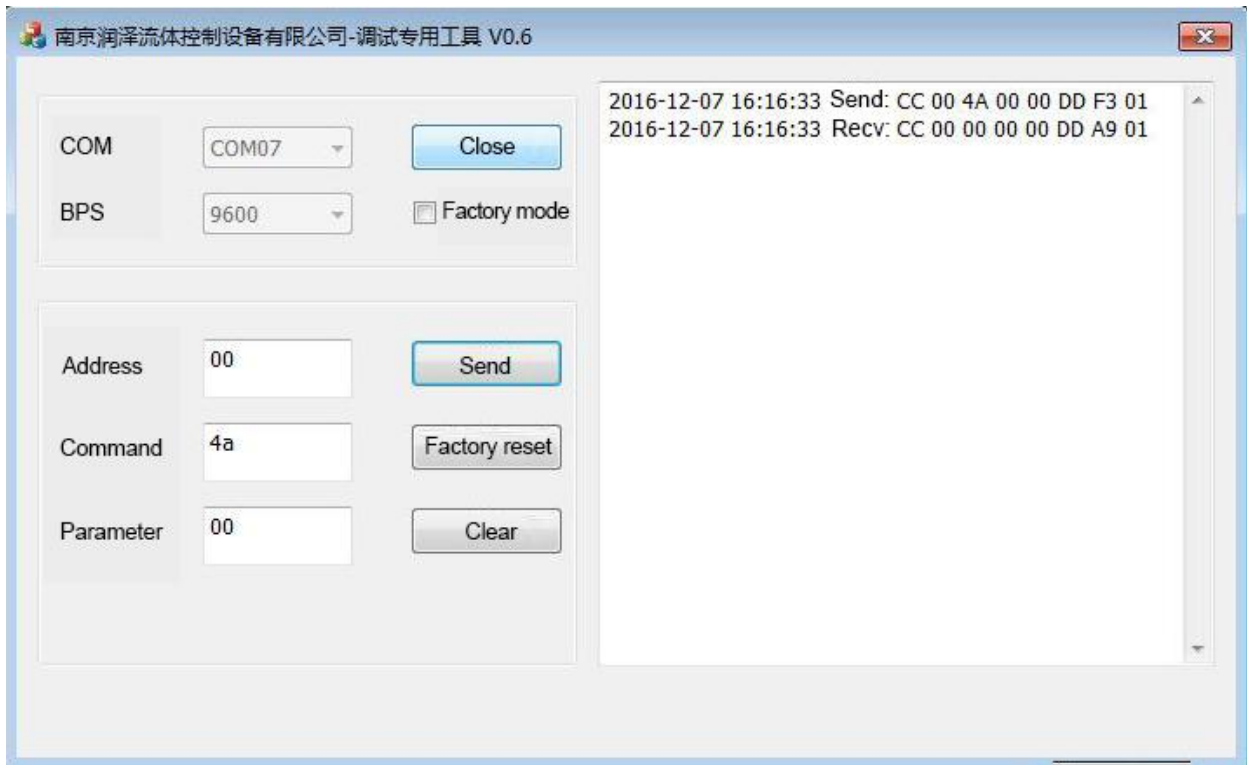

Figure 13

Received command B2=00 means device works in normal status and settings are successful.

Note: When RS485 control several devices, 0x4a is polling command, you need to resend polling command each time after sent a control command (B2=0x44 or 0x45), or received command with tells motor busy when send other commands (except for inquiry command).

- Send command: reset

B0	B1	B2	B3	B4	B5	B6	B7
0xCC	0x00	0x45	0x00	0x00	0xDD	0xEE	0x01

Response command

B0	B1	B2	B3	B4	B5	B6	B7
0xCC	0x00	0xFE	0x00	0x00	0xDD	0xA7	0x02

Debug results as Figure 14:



Figure 14

Note: Response command B2=0xFE means motor is working as command told, if send other commands now (except for inquiry command), response command will be 04(motor busy), if resend polling command 0x4a the response command will be 00 (motor normal working)

When RS485 control several devices, 0x4a is polling command, you need to resend polling command each time after sent a control command (B2=0x44 or 0x45), or received command with tells motor busy when send other commands (except for inquiry command).

□ Send command: control multiport valve switch to port 1

B0	B1	B2	B3	B4	B5	B6	B7
0xCC	0x00	0x44	0x01	0x00	0xDD	0xEE	0x01

Response command

B0	B1	B2	B3	B4	B5	B6	B7
0xCC	0x00	0xFE	0x00	0x00	0xDD	0xA7	0x02

Debug result as Figure 15:

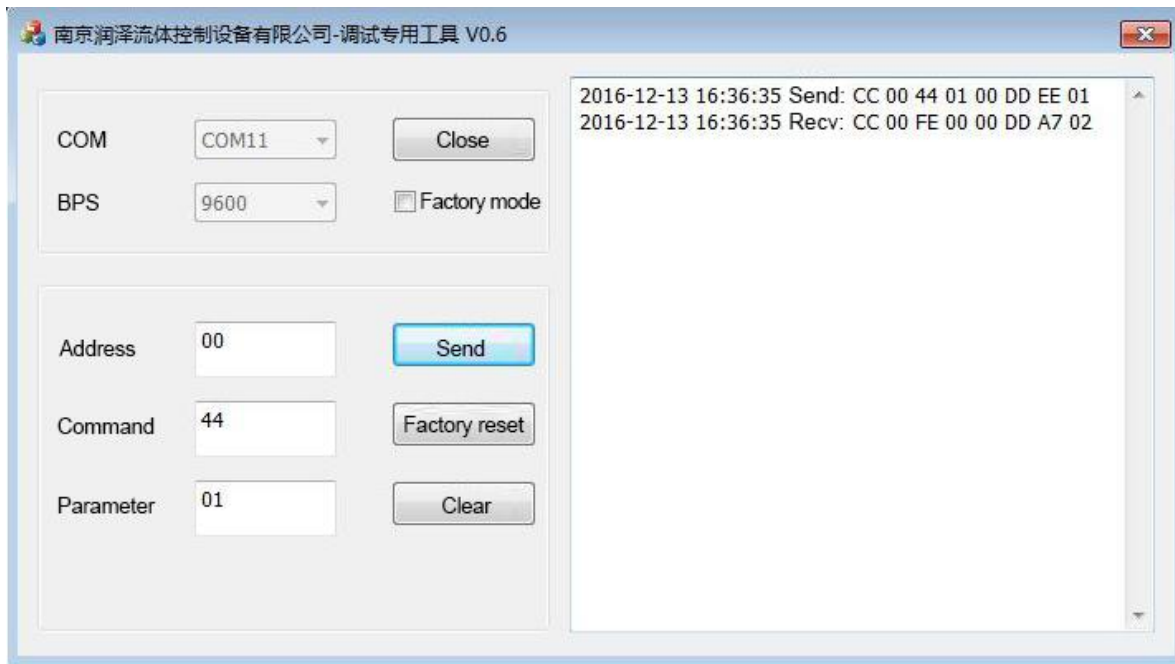

Figure 15

Note: Response command B2=0xFE means motor works normally, each time after send control command (B2=0x44 or 0x49) you need to resend reset command (B2=0x45) to reset the motor, or when resend port switching command, actual port will not the target port you expected.

Send command: Strong stop

B0	B1	B2	B3	B4	B5	B6	B7
0xCC	0x00	0x49	0x00	0x00	0xDD	0xF2	0x01

Response command

B0	B1	B2	B3	B4	B5	B6	B7
0xCC	0x00	0x00	0x00	0x00	0xDD	0xA9	0x01

Debug result as Figure 16:

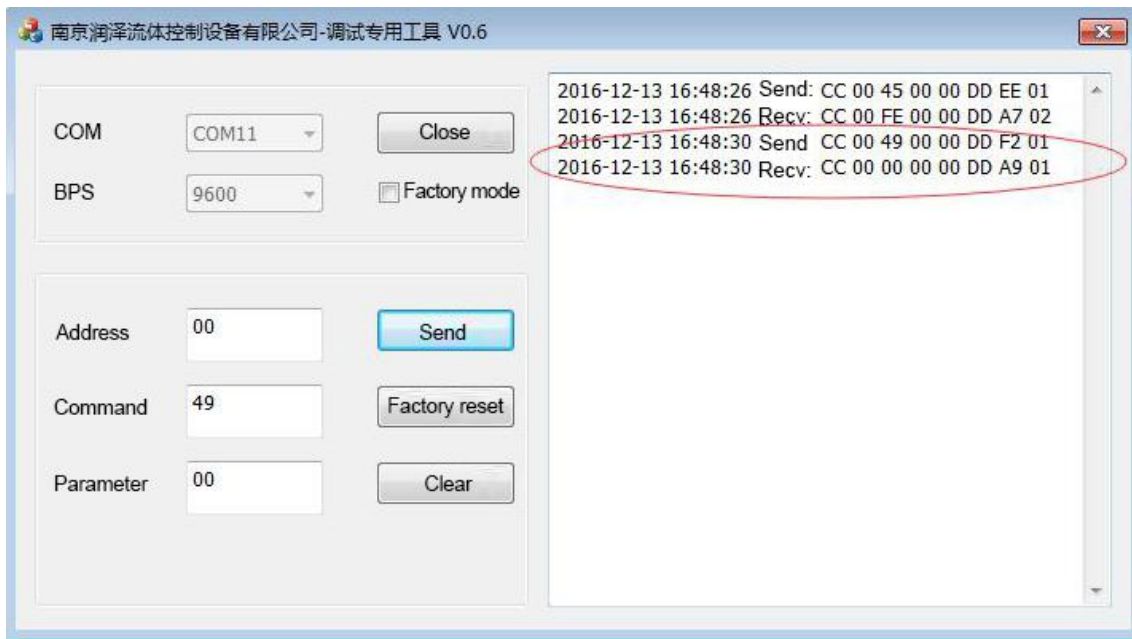

Figure 16

Note: Reset command “0x45” needs to be sent after “strong stop” sent.

When RS485 control several devices, 0x4a is polling command, polling command need to be sent to inquiry current status each time after control command (B2=0x44 or 0x45) was sent, response command B2=0xFE means motor works normally. Reset command need to be sent each time after control command (B2=0x44 or 0x49) was sent, after command “0x44” was sent, send polling command 0x4a then send reset command “0x45”

4.1.3 CAN Debug Instructions

(1) CAN Debug: CANTest_Setup_V2.23.exe



Figure 17

Open CAN debug you will see interface as figure 4-8

Step 1. Choose baud rate

Step 2. Click “confirm”, you will see interface as below figure 4-9

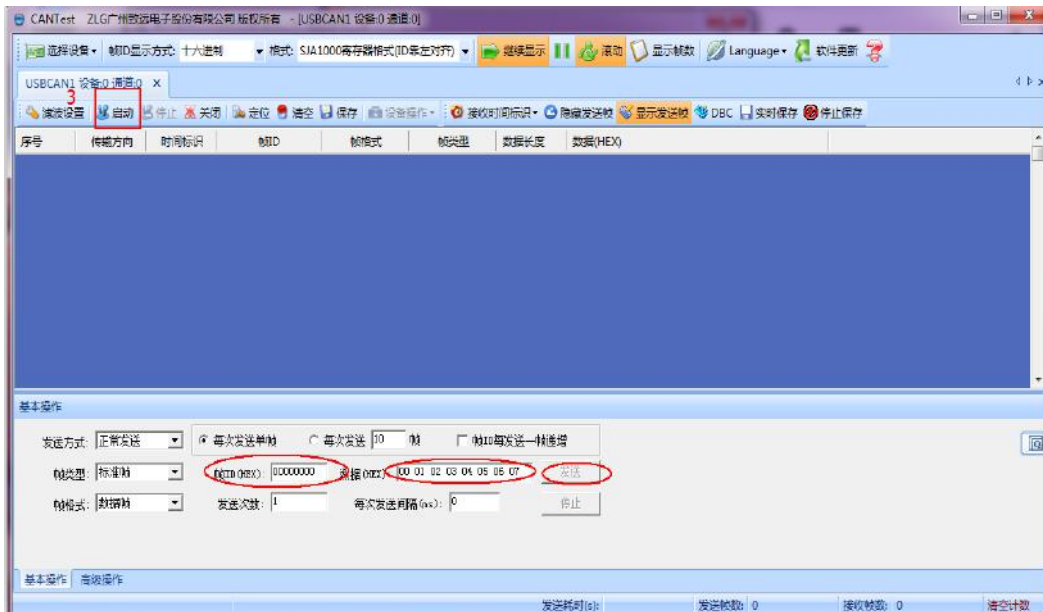

Figure 18

Step 3. Click “start” and input command to operate, or click “confirm and start CAN” in step 2 and input command to operate. Input “frame ID”(address) and “data”, click “send”.

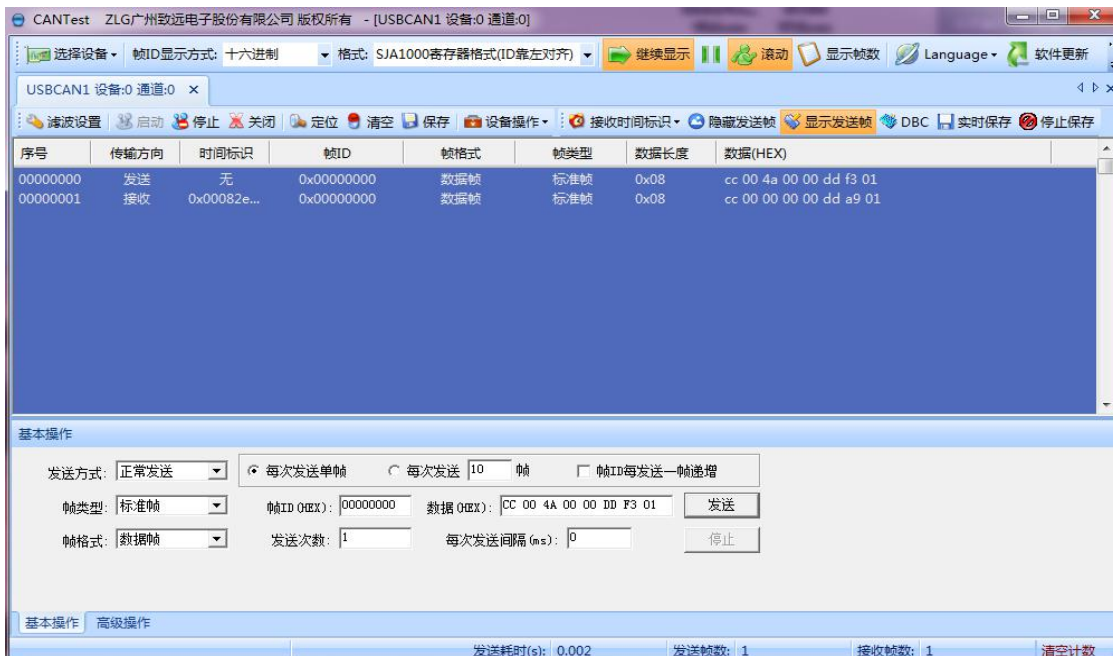

Figure 19

The center display area in figure 19 are sent and received commands. When input command, other options such as send mode, frame type, frame format, send times etc. are usually no need to revise and keep it as default parameters.

(2) CAN communication examples

□ Send command: reset

B0	B1	B2	B3	B4	B5	B6	B7
0xCC	0x00	0x45	0x00	0x00	0xDD	0xEE	0x01

Response command

B0	B1	B2	B3	B4	B5	B6	B7
0xCC	0x00	0x00	0x00	0x00	0xDD	0xA9	0x01

Debug result as Figure 20:

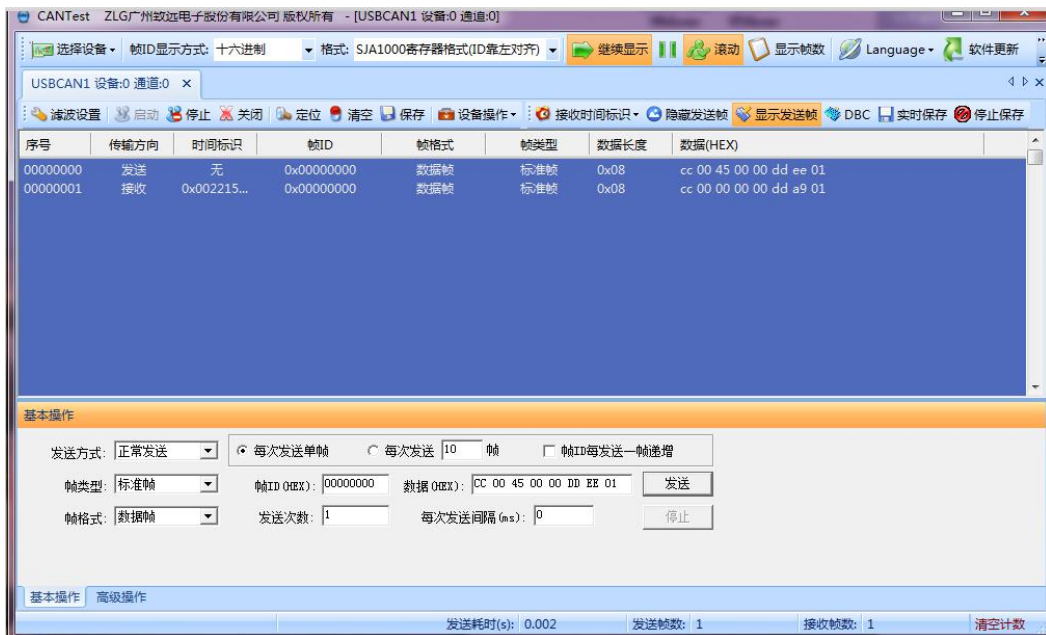

Figure 20

Received commands B2=00 means switching valve works normally and reset successfully.

4.2 Common problems and solutions

Breakdown	Cause
Power on but not work	1. working voltage is out of required voltage range

	2.connection wire loosen or broken
Fail to suction liquid	Maybe blocked by particles
Bubbles among liquid	Connection loosen
Solutions	
<ol style="list-style-type: none"> 1. check if pin voltage has some deviation with rated voltage 2. Check if fail connection, or check the circuit with multimeter 3. Take out the tube to remove particles 4. Replace the connectors into suitable size to keep the tightness 	

Safety precautions

- ◆ Please ensure input voltage match standard voltage of the device
- ◆ Connecting to power supply with original serial lines shipped with your products
- ◆ The communication modes (RS232, RS485, CAN) are under Non isolation mode.
- ◆ Please cover the unused ports with suitable plastic caps when laid aside to avoid impurity substance and air into the pump
- ◆ Please don't depart all parts of the device and keep labels on in case of warranty.
- ◆ For software part, please read carefully on the software operation instructions and communication protocol, do not input data randomly.
- ◆ Please dispose the rejection instruments as concerned national environmental protection regulations.
- ◆ When RS485 and CAN connect with several instruments, please take below connection way as reference.

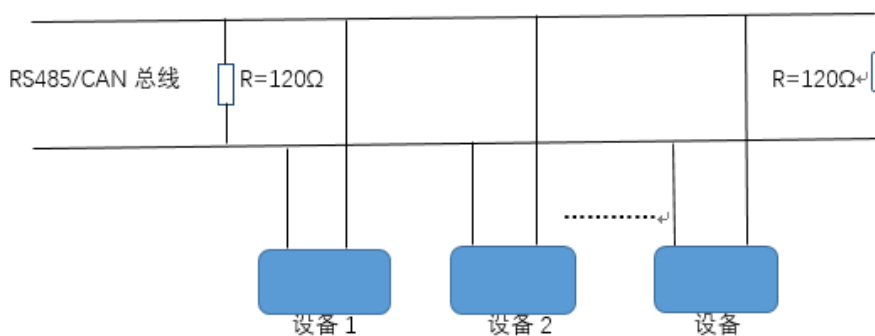

Figure 21



Nanjing Runze Fluid Control Equipment Co., Ltd

ADD: No.9 Tianxing West Road, Dongshan Street, Jiangning District, Nanjing, Jiangsu, China

Tel: +86-25-51197362

Phone: +86 17366384502

Technical Support: +86 13401932241

Contact email: min.zhu@runzeliuti.com

Company website: www.runzeliuti.com